

## Content

## VOLUME 13

President's Report	001
September Meeting Flyer	002
Upcoming Events	003
ASPE LA Holiday Party	005
IAPMO Weekly News	006
VP Technical Report	007



## President's Report

Vahan Margaryan CPD, GPD President

Hello Fellow ASPE-LA Members,

I hope this message finds you well and that you enjoyed a restful and meaningful holiday season surrounded by family and friends. As we begin the new year, I would like to extend my best wishes to all of you for continued health, happiness, and professional success in 2026.

Looking ahead, the ASPE-LA Chapter Board

encourages everyone to become more actively involved in our upcoming meetings and events. Your participation is vital to the strength of our organization and plays a key role in fostering a connected and engaged professional community. We truly hope to see more of you join us as we continue to grow together.

We would also like to extend our sincere thanks to everyone who attended and contributed to our  
**Continued on page 3**

AMERICAN SOCIETY OF PLUMBING ENGINEERS LOS ANGELES CHAPTER

**January 14, 2026, Meeting**

**LEED Updates for v5:**

**“Introduction and Important Changes for Plumbing Engineers”**

**Presenter: Mr. Frank Schwamborn,  
Senior Engineer, Arup**

**Author: Mr. Jake Zickerman, Engineer, ARUP**

**WHAT YOU WILL LEARN:**

The presentation will cover the following topics, with time for questions:

- What is LEED and how it’s changing.
- Overview of LEEDv5 water requirements and credits
- Approaches on how to deliver maximum water savings.

**MEETING LOCATION:**

In Person:

*COURTYARD BY MARRIOTT BURBANK  
2100 W EMPIRE AVE, BURBANK, CALIFORNIA 91504*

**MEETING SCHEDULE:**

5:30 pm – Check in

6:30 pm – 7:30 pm – Presentation

**COST: Pay at door only**

Meeting Fee:

RSVP - \$55 and Retired BOD: \$30

Without RSVP - \$60

**RSVP Online:**

**RSVP**

**By: January 13, 2026**

**THE SPEAKER:**



Frank regularly speaks to a wide range of audiences, sharing straightforward information about building performance, carbon emissions, and climate issues. He believes that clear communication and education are key for advancing climate solutions. By blending solid analysis with plain language, Frank helps people understand the facts and identify practical steps forward to advance equitable climate policies and practices.

If you have additional questions or needed information on his presentation, you can reach him at: [Frank.Schwamborn@arup.com](mailto:Frank.Schwamborn@arup.com) & [Jake.Zickerman@arup.com](mailto:Jake.Zickerman@arup.com)

For more information, visit our website [@www.aspela.com](http://www.aspela.com).



## Upcoming Events

### 2026 ASPE LA Golf Tournament

Friday, April 17th, 2026

#### Continued from page 1

recent Holiday Party. It was a wonderful opportunity to reconnect, celebrate, and enjoy the season together. A special highlight of the evening was the karaoke session, which brought plenty of laughter and energy—thanks in particular to the enthusiastic and memorable performances by Noelle and Thura. Their contributions truly made the night unforgettable.

Additionally, we would like to express our heartfelt appreciation to the band Single Trak for keeping the evening lively and entertaining. Their performance played a significant role in creating such an enjoyable atmosphere for all in attendance.

We also extend our gratitude to Bellezza Banquet Hall for their flexibility, dedication, and commitment to excellent service. Their efforts were instrumental in ensuring the success of the event.

Thank you again for being an important part of ASPE-LA. We look forward to seeing many of you at our upcoming meetings and events throughout the year.

#### CPD Exam Reminder

If you are planning to earn your Certified in Plumbing Design (CPD) credential in 2026, please note that the exam will be administered via remote proctoring from April 13–24, 2026 by the American Society of Plumbing Engineers. The CPD program is the only international credential for engineers and designers of plumbing systems, setting the standard for leadership in our industry and recognizing professionals with advanced expertise in plumbing system design and specification.

Be well, and stay well.

Continued on page 15



**weil aquatronics**

*Treating Water as a Resource™*

13630 San Antonio Drive Norwalk, California 90650  
TEL 800-74-PUMPS  
SAN DIEGO 619-233-1716 | LAS VEGAS 702-388-7300  
[www.weilaquatronics.com](http://www.weilaquatronics.com) | [info@weilaquatronics.com](mailto:info@weilaquatronics.com)



## Representing



- Submersible, vertical, and dry pit sewage and sump pumps; stainless steel and high-temperature options
- Condensate return, boiler feed, circulating pumps, variable-speed EC motors and controls
- Lift stations, submersible and vertical grinder pumps, "Slicer" pumps, vortex pumps, "Scum Blaster" systems
- High-efficiency water pressure booster system packages, UL and NSF certified



- Submersible and dry pit non-clog sewage, effluent, and wastewater pumps
- Grinder pumps, cutter pumps, vortex, jacketed pumps, and portable dewatering pumps
- High temperature and corrosion-resistant pumps



- Packaged variable and constant speed pumping systems since 1962
- Domestic water, HVAC, irrigation, water recycling, and fire pump packages, UL- and ETL-listed
- [Emergency water storage systems for critical facilities](#)
- Custom engineering and design capabilities



- Inline wastewater pumps eliminate the wet well with patented technology
- Lower installation and maintenance costs, and reduced ground excavation
- Patented DIPCut® impeller/shredder cuts fibrous materials and other solids
- Dramatically reduced downtime from clogged pumps
- Prevents sand and grease accumulation
- Eliminates hazardous environment classification



- Air-operated, clog-proof, odor-free Pneumatic Ejectors
- Self-priming Diaphragm Pumps for viscous liquids
- High-pressure positive displacement Plunger pumps

## HISHITANK

- Fiberglass reinforced plastic (FRP) and stainless steel above ground water storage tanks
- Typical uses: Potable water, greywater, rainwater, recycled water, irrigation, fire protection
- ICC Certified to AWWA D121-12, IAPMO PS 52-2019, IAPMO/ANSI Z1002, ANSI/NSF/CAN 61
- Modular design is ideal for retrofits and areas with limited access or irregularly shaped spaces
- Over 50 years experience and installations in more than 30 countries



- AQUALOOP Greywater, Rainwater, and Stormwater Treatment
  - 6 Log Reduction of Bacteria (99.9999%) and 99.7% Virus Removal
  - NSF 350 Certification
- PURAIN Self-Cleaning Pre-Filters for Rainwater Collection Systems
- DRAINMAX Tunnel Infiltration Products for On-Site Detention



- Sump & utility, effluent, double-seal grinder, and non-clog sewage pumps
- Fiberglass basins and packaged lift stations
- Control panels; float switches & alarms; backup systems; check valves; guide rail components



- Advanced oxidation process (AOP) controls biofilm, biofouling, scaling, and corrosion
- Bio-hydrox in use for Legionella remediation in over 30 states
- NSF/ANSI/CAN 60 Drinking Water Treatment Chemicals certified
- Does not create disinfection byproducts (DBP) as defined by EPA
- Fully automated treatment process - no requirement for highly trained operators



- Bypass and diverter valves for rainwater, greywater, and water source reuse applications
- IAPMO R&T tested for pressure, life cycle performance, and materials
- UL, IPC, and ASTM certifications
- Complies with Green Building Codes, Uniform and California Plumbing Codes

### ACCESSORIES:

- Control panels, alarms, level sensors
- Fiberglass sump basins
- Custom steel basins, covers, and frames
- Elevator sumps, holding tanks, and alarms
- Grease waste transfer systems
- Triple duty and butterfly valves
- Suction diffusers
- ASME expansion tanks, air separators

**SERVING THE BUILDING TRADES SINCE 1962**





## WASHINGTON WEEKLY



### House Approves Legislation to Expedite Natural Gas Pipeline Approvals

The U.S. House of Representatives passed a bill to accelerate federal permitting for interstate natural gas pipelines by designating the Federal Energy Regulatory Commission (FERC) as the lead agency. The legislation, called the Improving Interagency Coordination for Pipeline Reviews Act, allows FERC to include water quality assessments in its environmental reviews, reducing delays caused by separate state certifications under the Clean Water Act. This bill is part of a broader congressional effort to streamline permitting processes for energy infrastructure, alongside another bipartisan measure, the Promoting Efficient Review for Modern Infrastructure Today Act. Meanwhile, the Senate is working on a more comprehensive reform targeting the National Environmental Policy Act to speed up projects like electric transmission upgrades.

[Click Here For More Information](#)

### PERMIT Act Clears House with Strong Support from Homebuilding Industry

The House passed the PERMIT Act, a legislative package backed by NAHB to streamline Clean Water Act permitting while maintaining environmental protections. The act addresses challenges under Sections 404 and 402 by reducing regulatory burdens, cutting red tape, and improving predictability for builders. Key provisions include extending permit durations, clarifying WOTUS exclusions, tying NPDES conditions to site-specific impacts, and setting timelines for judicial reviews. Additional measures aim to reduce backlogs, support state permitting authority, and lower mitigation costs to help advance housing projects efficiently.

[Click Here For More Information](#)

Continued on page 9

## New Representative: Mainline Sales

**One Mission.  
One Focus.  
No Distractions.**

**Emergency equipment isn't just what we do. It's all we do.** Your safety is too important to entrust to just anyone. All Guardian emergency eyewash and shower products are inspected, fully assembled, and 100% water-tested in our Chicago facility, which means you receive the most reliable emergency equipment each time, every time. Your safety isn't just a priority. It's our only priority.

Visit [gesafety.com](http://gesafety.com) to learn more.



**Guardian**

EMERGENCY EYEWASH & SHOWER TECHNOLOGY



Represented by:  
**Mainline Sales**  
(877) 300-9346

**KIMAX<sup>®</sup> drainline systems for chemical waste applications**

Built to last. Proven in the field. Corrosion-resistant, long service life, code compliant, easy assembly.

Contact your local distributor:  
The George Yardley Company  
3401 W. Lake Center Drive  
Santa Ana, CA 92704  
(714) 241-7700  
info@georgeyardley.com

**SCHOTT**

## Technical Report

BY Thura Zin CPD, GPD

Happy New Year!

Wishing all our Chapter members and their families a year filled with success, new opportunities, and continued growth. May your projects flourish, your professional connections strengthen, and your endeavors be met with great accomplishments. Cheers to an exciting year ahead!

### December 2025 Meeting Recap – December 10, 2025 | Courtyard by Marriott, Burbank

The ASPE-LA monthly meeting was held on December 10, 2025, at the Courtyard by Marriott in Burbank. On behalf of the ASPE-LA Board of Directors, we extend our sincere thanks to Mr. John Bird, Western Regional Manager at Equipment Controls Company, for his excellent presentation titled “Introduction to Gas Regulators.”

Mr. Bird also shared plans to return for a future presentation focused on gas regulator sizing and specification.

If you would like a copy of the presentation, please contact us.

We had a great turnout, with 40 ASPE members and design professionals in attendance. Thank you to everyone who joined us!

### Upcoming Meeting – January 14, 2026 | Courtyard by Marriott, Burbank

We will kick off the New Year with Mr. Frank Schwamborn, Senior Engineer at ARUP, presenting “LEED v5 Updates – Introduction and Important Changes for Plumbing Engineers.”

This presentation is authored by Mr. Jake Zickerman,

**Continued on page 11**



**Chris Sweeny**

Business Development Manager

Cell: (310) 482-7182

Office: (951) 549-1000

✉ [chris@signaturesalesinc.com](mailto:chris@signaturesalesinc.com)

📍 2740 Palisades Drive  
Corona, CA 92882

[www.signaturesalesinc.com](http://www.signaturesalesinc.com)



1006 Brighton Court  
Vacaville, California 95687  
[www.daybreaktech.com](http://www.daybreaktech.com)

**Brett Barron**

SoCal Account Manager

C 714-904-2954

P 707-451-9335

F 707-451-9445

2500 E Imperial Hwy. #201

Brea, CA. 92821-6121

[brett@daybreaktech.com](mailto:brett@daybreaktech.com)

MANUFACTURERS' REPRESENTATIVE

# WDS WASTEWATER DIVERSION SYSTEMS, INC.

**MADE IN AMERICA**

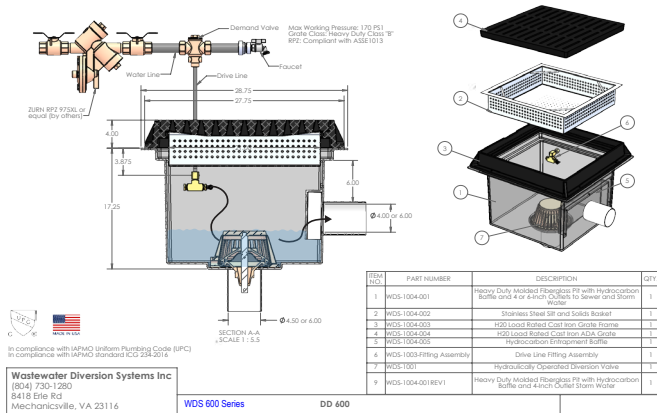

## No. 1 in Appearance, Construction, Performance & Warranty

### Advantages over Imported systems

- \*American made Lead Free Brass Diversion Valve
- \*American Made Lead Free Brass Demand Valve
- \*Heavy Duty Molded Hand Laid Fiberglass pit
- \*Chemical Resistant Fiberglass Resins and Gelcoats
- \*Baffled Stormwater Outlet for First Flush Protection
- \*Optional SS pits for Custom Sites
- \*Stainless Steel Silt & Solids Baskets
- \*H2O Cast Iron ADA Grate & Frame
- \*2" 4" or 6" Outlets to Sewer & Storm Water
- \*1" NPT in & out Demand Valve Thread
- \*No Electric or Roof needed
- \*Concrete pits unnecessary
- \*Provides Treatment for all Washdown Areas
- \*IAPMO UPC IGC234-2016 & CITIES APPROVED
- \*Meets CA Prop 65 Requirements

### Applications

- \*Car Wash & Detail Sites
- \*Beach, Deck & Pool Showers
- \*First Responder Chemical Showers
- \*Trash Bin Drainage Areas @ Schools & Fast-Food Sites
- \*Roof Top Dog Parks and Kennels
- \*Auto Part Recyclers
- \*Marinas & Boat Wash Down
- \*Loading Docks
- \*Aircraft Washdown

### How it Works

The Hydraulic Actuated Diversion Valves by Wastewater Diversion Systems will automatically send all wash water to the sewer and clean rainwater to the storm drain.

When the demand valve detects water use on the wash pad it sends water down the drive line to hydraulically actuate the pit mounted diversion valve sending all wash water entering the pit to the sewer.

When washing is finished and detected by the demand valve, drive line water also ceases allowing the diversion valve to close.

Valve is closed; sewer is sealed and protected from rainwater. The baffled stormwater outlet performing as an oil water separator will keep free floating pollutants from a First Flush of rain inside the pit to be sent to the sewer at beginning of next wash down operation.

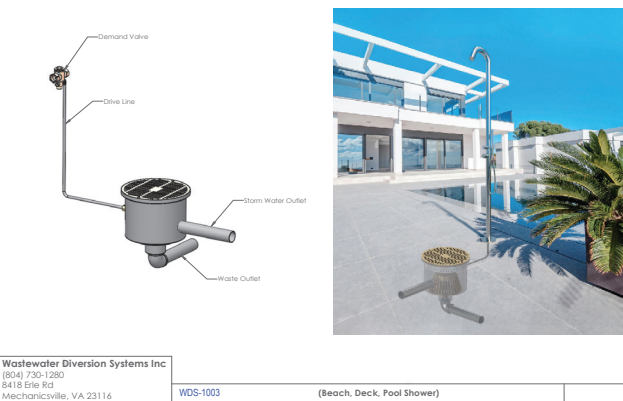
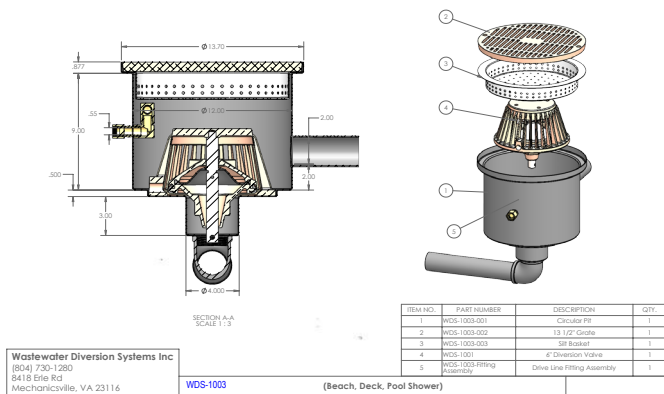

IAPMO R&T Tested & Complies with IGC234-2016

**THE BEST DIVERSION SYSTEMS**  
**WORLDWIDE**

**P: 804-730-1280**

**E: foxwwdsusa@aol.com**

**W: eeeusa.net**

**PO Box 389**  
**Mechanicsville,**  
**VA 23111**

## Jeff Atlas

Territory Sales Manager

### Rinnai America Corporation

103 International Drive | Peachtree City, GA 30269  
Toll Free: 1-800-621-9419  
Mobile: 661-456-6682 | Tech Support: 1-888-746-6247  
E-mail: jatlas@rinnai.us  
Website: rinnai.us

**Rinnai**



### Matthew Farrell

1450 Railroad Street  
Corona, CA 92882-6929

WWW.RENCOSALES.COM

office - 800.273.6267  
fax - 951.371.3635  
fax - ariz/nev - 877.251.2659  
cell - 951.339.0153  
matthewf@rencosales.com

Continued from page 6



### Federal Judge Orders FEMA to Restore Billions in Disaster Mitigation Funding

A federal judge ruled that the Trump administration unlawfully terminated FEMA's Building Resilient Infrastructure and Communities (BRIC) program, which funds pre-disaster mitigation projects. Judge Richard Stearns found the administration lacked authority to cancel the program and divert more than \$4 billion in funds, calling the move an unconstitutional encroachment on Congress's power. The court ordered FEMA to reinstate BRIC immediately, emphasizing its critical role in protecting communities from natural disasters. The lawsuit, led by 20 states, argued that ending BRIC forced delays or cancellations of hundreds of infrastructure projects nationwide.

[Click Here For More Information](#)



### Federal Regulators Order LADWP to Inspect Drinking Water Reservoirs and Tanks

LADWP has agreed to inspect nearly 100 drinking water reservoirs and tanks and clean more than 50 of them under a consent order with the EPA to address Safe Drinking Water Act violations. The move follows a 2024 EPA inspection that found maintenance issues, such as unprotected openings and inconsistent cleaning schedules, which could pose contamination risks. LADWP, which serves 3.8 million customers, must complete inspections by Dec. 31, 2031, and take corrective actions to improve system reliability and protect public health.

[Click Here For More Information](#)



# ELMCO STEWART

Anne Yardley  
ayardley@elmcostewart.com  
Architectural and Engineered Solutions

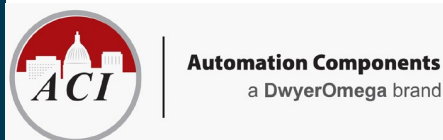



**Brian Wright**

Business Development Manager

Cell: (818) 792-0843  
Office: (951) 549-1000

✉ [brian@signaturesalesinc.com](mailto:brian@signaturesalesinc.com)

📍 2740 Palisades Drive  
Corona, CA 92882

[www.signaturesalesinc.com](http://www.signaturesalesinc.com)



**Marissa Ruiz**

Outside Sales

Cell: (951) 836-1353  
Office: (951) 549-1000

✉ [marissa@signaturesalesinc.com](mailto:marissa@signaturesalesinc.com)

📍 2740 Palisades Drive  
Corona, CA 92882

[www.signaturesalesinc.com](http://www.signaturesalesinc.com)



**Continued from page 7**

Plumbing Engineer, ARUP San Francisco Office.

Topics will include:

What LEED is and how it is evolving

An overview of LEED v5 water requirements and credits

Strategies to achieve maximum water savings

...and more!

**ASPE Los Angeles Chapter Holiday Party – Saturday, December 13, 2025**

Our annual ASPE-LA Holiday Party was a great success. Thank you to everyone who attended, as well as those who wished to join but were unable due to prior commitments.

**ASPE Los Angeles 2026 Golf Tournament – Friday, April 17, 2026**

Our annual ASPE-LA 62nd Anniversary Donald F. Dickerson Golf Tournament will be held on Friday, April 17, 2026, at Brookside Golf & Country Club.

Please save the date and plan to join us. Sponsorship opportunities at all levels are available.

**Get Involved**

**Continued on page 15**



1450 RAILROAD STREET

CORONA, CA 92882

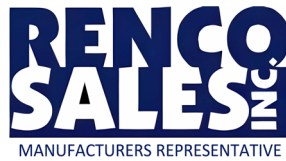

PHONE: (951)371-8848

FAX: (951)371-3635

### ADVANCED AQUADUCK SYSTEMS

Rectangular under walk drainage pipe and fittings, water heater pans, and duck-pullers  
[WWW.AQUADUCKSYSTEMS.COM](http://WWW.AQUADUCKSYSTEMS.COM)

### DIV 22



A WATTS Brand

Thermostatic mixing valves, Keltech heaters, wash-fountains, emergency equipment, showers, lavatories, patient care, anti-ligature  
[WWW.BRADLEYCORP.COM](http://WWW.BRADLEYCORP.COM)

### DIV 10



A WATTS Brand

Bathroom accessories, Elvari designer accessories, phenolic lockers, benches, cubbies and partitions, Euro partitions, stainless steel partitions  
[WWW.BRADLEYCORP.COM](http://WWW.BRADLEYCORP.COM)

## CHICAGO FAUCETS

Geberit Group

Commercial, industrial, institutional, food service, electronic, laboratory, and light commercial faucets  
[WWW.CHICAGOFAUCETS.COM](http://WWW.CHICAGOFAUCETS.COM)



ABS and PVC fittings, irrigation, pool and spa, plumbing, agricultural  
[WWW.DURAPLASTICS.COM](http://WWW.DURAPLASTICS.COM)

## FIAT PRODUCTS

Specialty products and plumbing fixtures designed for every application, including shower floors, mop basins, pet wash stations, and more  
[WWW.FIATPRODUCTS.COM](http://WWW.FIATPRODUCTS.COM)



Flexible gas corrugated stainless steel tubing, fittings, and accessories  
[WWW.GASTITE.COM](http://WWW.GASTITE.COM)

## GATCO

FINE BATHWARE

High quality designer bathroom towel bars, mirrors, shower curtain rods, and counter-top accessories  
[WWW.GATCO-INC.COM](http://WWW.GATCO-INC.COM)

## Global Flex Mfg.

Seismic, stainless steel, bronze, and teflon hose assemblies in sizes ranging from 1/4" to 12" diameter  
[WWW.GLOBALFELXMFG.COM](http://WWW.GLOBALFELXMFG.COM)



Laboratory service panels, utility controllers and solenoid  
[WWW.ISIMET.COM](http://WWW.ISIMET.COM)

## JOSAM

A WATTS Brand

Commercial drainage products, stainless steel push-fit pipe and fittings, trench drains, stainless steel drains  
[WWW.JOSAM.COM](http://WWW.JOSAM.COM)



Adjustable nylon based roof supports, mechanical supports, and tracking  
[WWW.MAPAPRODUCTS.COM](http://WWW.MAPAPRODUCTS.COM)

## MATCO NORCA

Supplier of globally sourced, code-compliant plumbing and PVF products for use in residential, commercial and industrial  
[WWW.MATCO-NORCA.COM](http://WWW.MATCO-NORCA.COM)

## McGUIRE

Plumbing specialty in cast brass P-traps, sink and lavatory drain strainers, Pro-Wrap ADA, and heavy-pattern supply stops  
[WWW.MCGUIREMFG.COM](http://WWW.MCGUIREMFG.COM)



Since 1910 water delivery system, Quasar, bottle fillers, drinking fountains, retrofit for existing fountains, outdoor wall mount  
[WWW.OASISCOOLERS.COM](http://WWW.OASISCOOLERS.COM)

## Pacific Plastics

PVC DWV, Sch40 PVC Piping, Sch80 PVC, SDR Gasketed, SDR Solvent Weld, Sch40 Gas Piping, Reclaimed Water Piping, Electrical Conduit Piping  
[WWW.PACIFICPLASTICS.US](http://WWW.PACIFICPLASTICS.US)



Terrazzo mop sinks, shower pans, and outdoor fountains and showers  
[WWW.STERNWILLIAMS.COM](http://WWW.STERNWILLIAMS.COM)



Complete line of bath wastes, tub trim kits, and lavatory drain accessories  
[WWW.WATCOMFG.COM](http://WWW.WATCOMFG.COM)



Commercial/Residential wall, roof, and yard hydrants for warm and freezing climates  
[WWW.WOODFORDMFG.COM](http://WWW.WOODFORDMFG.COM)



Industrial Stainless Steel Sinks,  
Work Tables & Equipment



Backflow Prevention



Commercial and Residential  
Water Heaters



Self-adjusting Thermostatic  
Balancing Valves



Earthquake Valves  
(1/2" to 6")



Expansion Loops, Seismic and  
Flexible Isolation Connectors



**KINDRED**  
Stainless Steel, Granite,  
Fireclay Sinks



ABS/PVC DWV, SCH40 and  
CPVC Pipe and Fittings



Residential and Commercial  
Filtration and Conditioning



Drinking Fountains, Electric  
Water Coolers & Emergency  
Equipment



Industrial  
Stainless Steel Tanks



Boilers, Volume Water Heaters,  
and Storage Tanks



Engineered Rooftop Support  
Systems



PP-RCT Pipe and Fittings,  
Including Pre-insulated



ADA P-trap Covers



Domestic Water  
Booster Pumps



Electrical Heat Tracing Solutions  
and Project Services



Ball, Gate, Globe, Check, and  
Tankless Valves



Trap Primers, Outlet Boxes,  
Commercial Drains, Water  
Hammer Arresters



Commercial Water Treatment  
Solutions



Stainless Steel Plumbing  
Fixtures for Commercial,  
Healthcare, & Security  
Applications

2740 Palisades Dr.  
Corona, CA 92882

[www.signaturesalesinc.com](http://www.signaturesalesinc.com)

PHONE: (951) 549-1000  
FAX: (951) 549-0015

[info@signaturesalesinc.com](mailto:info@signaturesalesinc.com)

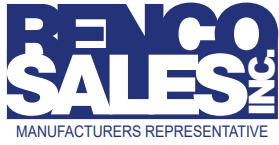

**Mike Brown**

1450 Railroad Street  
Corona, CA 92882-6929

WWW.RENCOSALES.COM

tel - 951.371.8848  
fax - 951.371.3635  
cell - 951.833.2805

mikeb@rencosales.com



**Casey Wise**

1450 Railroad Street  
Corona, CA 92882-6929

WWW.RENCOSALES.COM

tel - 951.371.8848  
fax - 951.371.3635  
cell - 951.532.6109

caseyw@rencosales.com

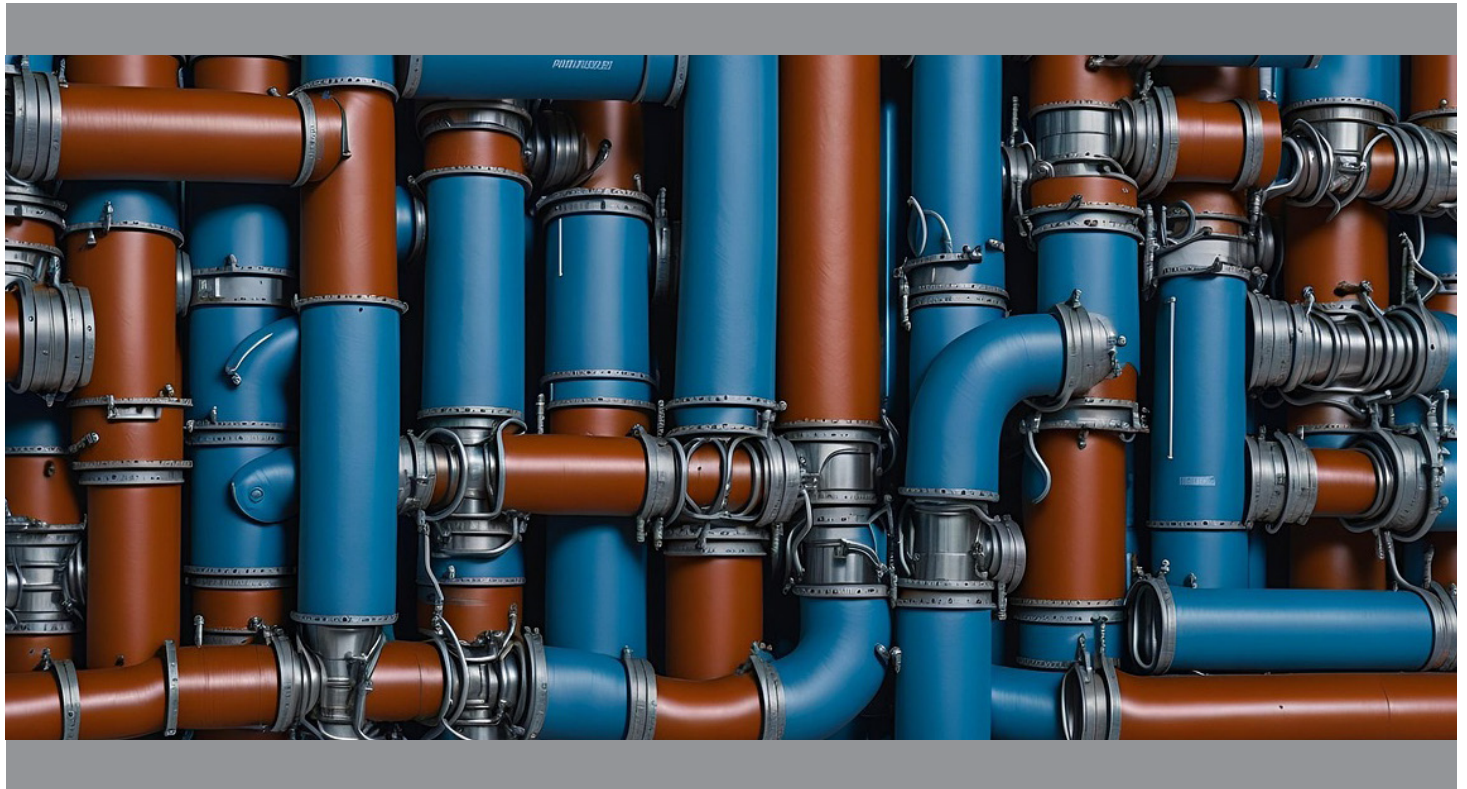

2029 Verdugo Blvd. #236  
Montrose, CA 91020

**Linda Deunay**

linda@enviroproductswest.com

o. 888.959.2937x101  
c. 818.687.6910  
f. 888.959.2973



2029 Verdugo Blvd. #236  
Montrose, CA 91020

**John Deunay, CPD**

john@enviroproductswest.com

o. 888.959.2937x302  
c. 818.687.6911  
f. 888.959.2973

ENVIROPRODUCTSWEST.COM

ENVIROPRODUCTSWEST.COM

**Continued from page 11**

2026 is an election year for the ASPE Los Angeles Chapter. If you are interested in running for a position on the Board of Directors, please let us know. The election will be held during the April 2026 monthly meeting.

We encourage all qualified members to participate. Current Board members welcome anyone who wishes to contribute their time, experience, and ideas.

If you have suggestions for future technical program topics, we would love to hear from you. Please contact any Board member with your ideas.

Stay connected by checking your inbox for announcements and by visiting the Technical Calendar on our website for upcoming events.

Thank you for your continued participation and support. We look forward to seeing you at our upcoming meetings.

Stay safe and take care.





**PLUMBING**  
TECHNICAL SERVICES



**NOTHING PROTECTS LIKE GRAY**



John Marc Shelly  
Regional Manager  
Technical Services  
901.240.6103  
[johnmarc.shelly@mcwanepbgrp.com](mailto:johnmarc.shelly@mcwanepbgrp.com)



**ENVIROMENTAL PRODUCTS**



**Xerxes**

High Volume Fiberglass Grease Interceptor  
Oil Water Separators & Storm Water Tanks



**Grease Guardian**

Point of Source Grease Removal Device



**FogEnforcer**

Ultra High Super Capacity Grease Interceptors



**Franke**

Commercial and Sanitary Solutions

**PUMPS, PUMP SYSTEMS & CONTROLS**



**Ebara**

FM Cast Iron & CSA Stainless Steel Pumps



**Goulds Pumps**

CSA Cast Iron & Stainless Steel Pumps



**Landia**

Cutter Pumps Submersible & Vertical Column



**Sulzer / ABS**

FM & CSA Submersible Pumps & Mixers



**Ashland Pump**

CSA Cast Iron Sump & Sewage Pumps



**Tramco Pumps**

Vertical Column Sump & Sewage Pumps



**Topp Industries**

Fiberglass Basins, Packaged Lift Stations



**VC Systems**

NSF/ANSI 61 & 372 Booster Systems



**Watertronics**

Rainwater / Stormwater Harvesting Systems

**ACCESSORIES**

U.L. LISTED CONTROL PANELS  
FIBERGLASS BASINS  
FABRICATED STEEL PRODUCTS

LEVEL CONTROLS & FLOATS  
ELEVATOR ALARMS SYSTEMS  
HYDRO-PNEUMATIC TANKS



Mainline Sales has over forty years experience as a professional manufacturers' representative firm covering **California, Nevada, Arizona, and Hawaii** :

- Plumbing (Residential & Commercial)
- Mechanical
- Fire Protection
- Industrial
- Irrigation
- Waterworks (Water & Sewer).

Mainline Sales operates **(6)** distribution centers and **(7)** offices strategically located in **Anaheim, San Diego, The Bay, Sacramento, Las Vegas, Phoenix, and Hawaii** which are supported by a seasoned staff of professionals that are dedicated to satisfying the value chain (specifiers, architects, builders, contractors, municipalities and distributors) from the initial specification through the final shipment, and after-market service of installed product.

We believe in delivering superior results for the manufacturers we have the honor of representing, by supporting our strategic relationships with the best people, systems, and analytics.

Anaheim Headquarters  
659 E. Ball Road | Anaheim, CA 92805

Customer Care (877) 300-9346  
cs@mlsalesinc.com | www.mlsalesinc.com

# Halo<sup>®</sup> Eye and Eye/Face Wash

Exceptional Contaminant Relief



Pedestal | Wall Mounted | Swing Activated | Recessed Cabinet  
Concealed Cabinet | Heat Trace Combination Units  
Combination Drench Showers | Enclosed Safety Showers

[bradleycorp.com](http://bradleycorp.com)



A WATTS Brand

# Rinnai® REHP SERIES™

## Electric Heat Pump Water Heater

### Technology and Comfort Combined

Rinnai now offers one of the most efficient and sustainable residential water heating solutions available, the Rinnai Electric Heat Pump Water Heater (REHP). The REHP delivers consistent hot water by extracting heat from the surrounding air and converting it to hot water while producing zero emissions.

When you install the REHP in your home, you are assured of meeting the highest efficiency standards and reduced energy usage and costs.

### Product Highlights

#### Efficiency

- Energy Star® 5.0
- UEF of 3.75/50 GL and 4.0/80 GL
- Meets the highest level of Builder efficiency standards
  - Only Builder model with CTA-2045
  - Title 24 Compliant
- Meets the highest level of federal and state rebate requirements
  - IRA (45L) tax credit eligible
- NEEA Tier 4
- High Cool Climate Efficiency (CCE)

#### Performance

- Designed with variable speed fan for whisper quiet operation
- Wide Operating Range as low as 37°F - 109°F
- Designed with a Micro Channel Heat Exchanger Condenser to optimize the heat transfer and enhance energy savings for best in class recovery rate
- 4.5 KW back up elements for extra comfort
- Demand-Response Enabled- Save money by reducing energy usage during peak demand





#### Installation and Serviceability

- Zero Clearance- Gain back net living space with less install footprint for flexible installation
- Installs as easily as an electric water heater
- Easy troubleshooting and serviceability
- Duct ready to install in tight spaces



5 Operating Modes to meet any hot water demand



Part #	Included Accessories	
107000677	T&P Valve	
107000674	Drainage Pipe	
107000678	Drain Valve	
Part #	Optional Accessories	
103000120	EHPWH Ducting Kit	
103000119	EHPWH Leak Sensor Valve	

Rinnai. Learn more at [rinnai.us](http://rinnai.us)

[rinnai.us](http://rinnai.us) | [rinnai.ca](http://rinnai.ca)

Rinnai America Corporation | 103 International Drive | Peachtree City, Georgia 30269 | [rinnai.us](http://rinnai.us) | [rinnai.ca](http://rinnai.ca) | 1-800-621-9419



PROUD SPONSOR



Official Water Heater of Stewart-Haas Racing and Tony Stewart Racing

FOLDS OF HONOR

2024165

Copyright 2024 Rinnai America Corporation. All rights reserved. Rinnai® and Creating a healthier way of living® are registered trademarks of Rinnai Corporation used under license by Rinnai America Corporation. Rinnai Electric Heat Pump Water Heater™ and Every Detail Matters™ are the trademarks of Rinnai America Corporation. Rinnai America Corporation continually updates materials, and as such, content is subject to change without notice.

2/2024

# Your Premier Providers of Life, Property and Asset Protection Solutions

## CLEAN AGENT FIRE SUPPRESSION

Our fire protection specialists bring you the finest in fire protection, including the most cost effective to the most environmentally sustainable products available. Fike SF 1230™, FK-5-1-12, and Fike Inert Gas Systems have the lowest environmental impacts. Ecaro 25 remains a cost-effective halon system replacement. We offer a full line of systems for a variety of applications:

- Cost-Effective Clean Agent Systems
- Sustainable Inert Gas Systems
- Drop-in Halon Replacement
- In Cabinet / Small-Space Protection
- CO<sub>2</sub> Systems

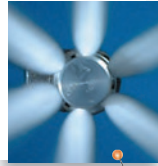

ECARO 25



Fike SF 1230™



Fike Inert Gas Systems

## FIRE ALARM AND LIFE SAFETY

Our code-compliant fire alarm systems with specialty detection utilize high quality equipment from industry-leading manufacturers. We have extensive experience in projects from small commercial buildings, to large high-rise to sprawling industrial complexes. Our NICET certified sales team, designers, project managers, and technicians strive to exceed our client expectations.



- Addressable, Conventional, and Networked Fire Alarm Systems
- Voice Evacuation
- Linear Heat Detection
- Air Sampling
- Pre-action Sprinkler Detection & Control



## EMERGENCY POWER SHUTDOWN MANAGEMENT SYSTEM (EPSMS)

Fike's Emergency Power Shutdown Management System (EPSMS) is designed to consolidate and control equipment emergency power off in a timely, efficient and coordinated manner. EPSMS is used in many applications to:

- De-energize equipment during a fire
- Close fire dampers and turn off HVAC to contain fire and maintain proper concentration of fire suppressant
- Safely shutdown equipment during a flood or sprinkler system discharge
- Help protect fire department personnel from electrocution when fighting a fire



Call today for your life safety evaluation.



714 257-2244  
www.FPSYS.com

Need Continuing Education?  
Schedule a lunch and learn with [DOIDs@FPSYS.com](mailto:DOIDs@FPSYS.com)

**American Society of Plumbing Engineers**

**Officers - Board of Directors**

Published by American Society of Plumbing Engineers, Los Angeles Chapter  
www.aspela.com // news.aspela.com

Over fifty years of dedication to the health and safety of the Southern California Community.  
A non-profit corporation. Local chapters do not speak for the society.



**President**  
**VAHAN MARGARYAN, CPD,**  
**GPD**  
**ARUP**  
(310) 422-7425  
vahan.margaryan@arup.com



**Corresponding Secretary**  
**NOELLE MELZER**  
Spears Manufacturing  
nmelzer@spearsmfg.net



**Editor**  
**MATT FARRELL**  
Renco Sales, Inc.  
(951)339-0153  
news.aspela@gmail.com



**Vice President Technical**  
**THURA ZIN CPD, GPD**  
**ARUP**  
(310) 650-7734  
thurazin53@gmail.com



**Treasurer**  
**EDGAR OCHOA**  
Southcoast Engineering  
Group  
(818) 224-2700  
eochoa@sceginco.com



**Women of ASPE Region 4**  
**Liaison**  
**LINDA DEUNAY**  
Enviro Products West  
(818) 687-6910  
linda@epwest.com



**Vice President Legislative**  
**AMIR TABAKH**  
**LADWP**  
amir.tabakh@ladwp.com



**Administrative Secretary**  
**JEFF ATLAS**  
Rinnai  
(661) 478-4565  
aspenews@gmail.com



**Chapter Affiliate Liaison:**  
**GUILLERMO NEGRON**  
Lixil  
giullermo.negron@lixil.com

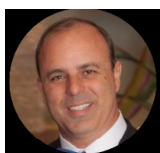

**Vice President Membership**  
**GABRIEL STARKMAN**  
WAHASO - Water Harvesting Solutions  
Gabriels@wahaso.com



**Chairman Board of**  
**Governors**  
**COREY NAKANISHI**  
PBS Engineers, Inc.  
cnakanishi@pbsengineers.com